



# Information for First & Second Responders Emergency Response Guide For Vehicle:

Li-ion

2024 Acura ZDX  
Electric Vehicle

# ZDX



Version 1

This guide has been prepared to assist emergency response professionals in identifying a 2024 Acura ZDX vehicle and safely respond to incidents involving this vehicle.

Copies of this guide and other emergency response guides are available for reference or downloading at <https://techinfo.honda.com>.

For questions, please contact your local Acura dealer or Acura Client Service at **1-888-922-8729**.

Acura wishes to thank emergency response professionals for their concern and efforts in protecting Acura clients and the general public.



## Contents

<b>1. Identification / Recognition</b>	<b>Page 04</b>
<b>2. Immobilization / Stabilization / Lifting</b>	<b>Page 07</b>
<b>3. Disable Direct Hazards / Safety Regulations</b>	<b>Page 09</b>
<b>4. Access to the Occupants</b>	<b>Page 13</b>
<b>5. Stored Energy / Liquids / Gases / Solids</b>	<b>Page 16</b>
<b>6. In Case of Fire</b>	<b>Page 17</b>
<b>7. In Case of Submersion</b>	<b>Page 18</b>
<b>8. Towing / Transportation / Storage</b>	<b>Page 19</b>
<b>9. Important Additional Information</b>	<b>Page 22</b>
<b>10. Explanation of Pictograms Used</b>	<b>Page 28</b>

The Acura ZDX can be identified by the **ZDX** and the **e:** emblem mounted on the tailgate.



The ZDX can also be identified by inspecting the VIN at the three locations shown below.

The characters 4 thru 6 of the VIN will show either, **KHM**, **KHN**, or **XHP** indicating that it is a ZDX.

4W5**XHP**\*\*\*\*\*000001

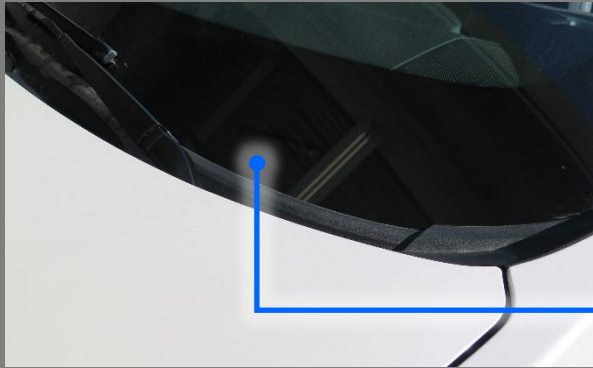

VIN plate located on the lower-right corner of the front windshield

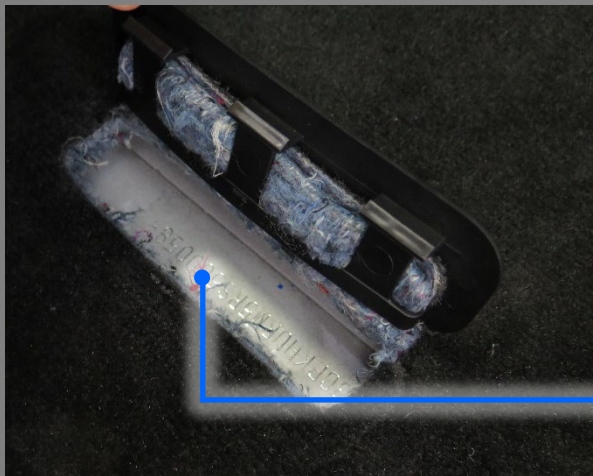

Stamped onto the floor panel in front of the passenger's side seat under a plastic panel

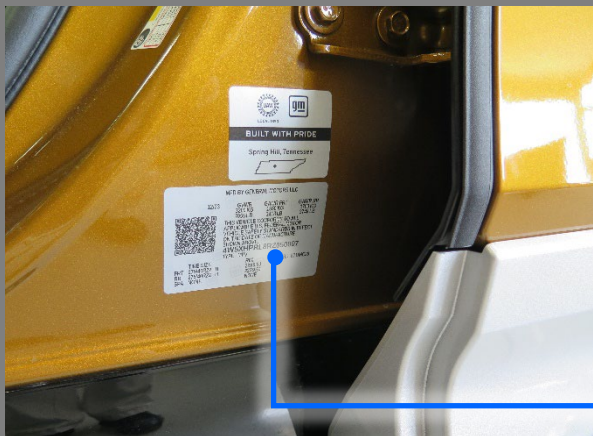

Printed on the VIN label on the driver's side doorjamb

## High-Voltage Battery

The high-voltage battery is a Class B, Li-ion battery that is mounted under the vehicle and is a structural part of the floor pan.

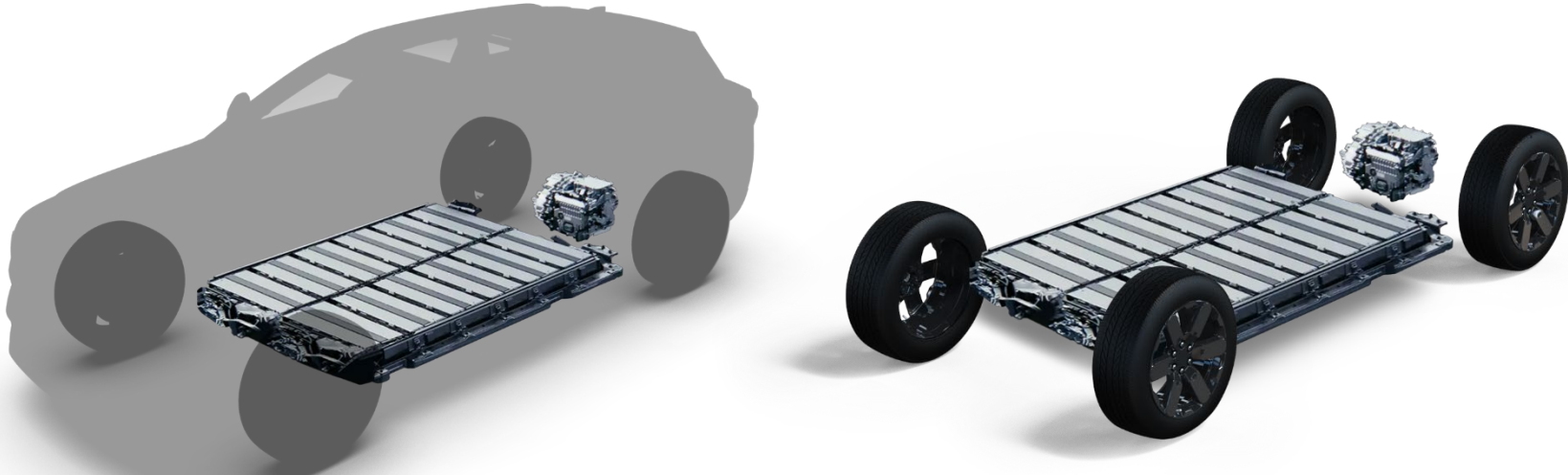

The high-voltage battery warning label is located on the top of the left headlamp.



### Immobilize Vehicle

- Block the wheels.
- Follow procedures for conventional vehicles.

#### Electric Parking Brake (EPB)

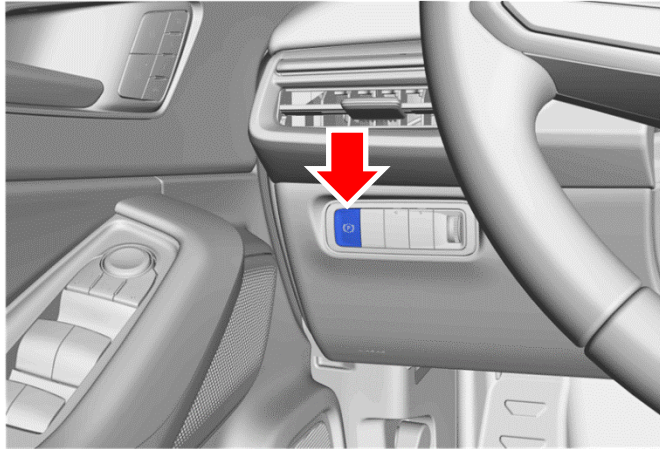

#### Applying the Electric Parking Brake (EPB)

Press the EPB switch momentarily. The red parking brake status light on the driver instrument panel will flash and will remain on once the EPB is fully applied.

#### Releasing the Electric Parking Brake

1. Turn the ignition on or to ACC/ACCESSORY.
2. Apply and hold the brake pedal.
3. Press the EPB switch momentarily. The EPB is released when the red parking brake status light turns off.

#### Electric Drive Unit Shift Lever

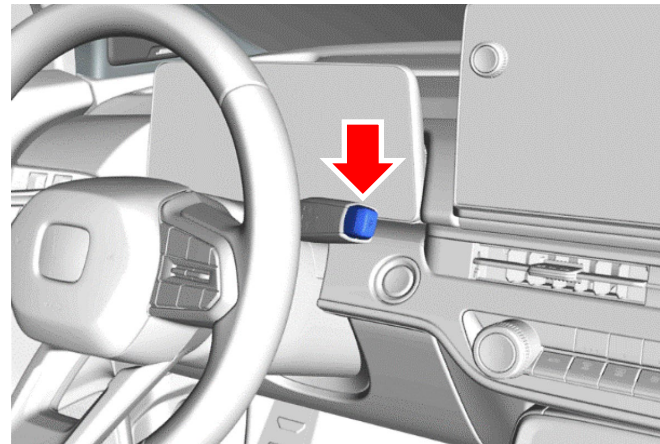

Press the button at the end of the shift lever to shift to P (Park).



### Immobilize Vehicle (continued)

#### Power Button

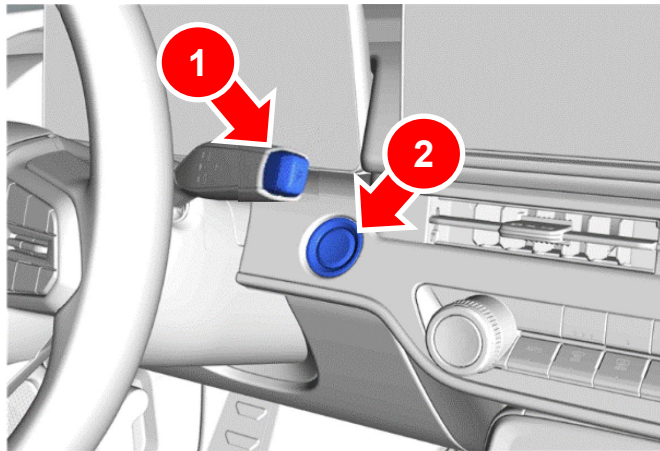

To turn the vehicle off, press the button on top of the shift lever to shift to **P (Park)** and press the **POWER** button.

Alternatively, press and hold the **POWER** button. The electric drive unit will shift to **P (Park)** then shut-off automatically.

#### Lifting Points

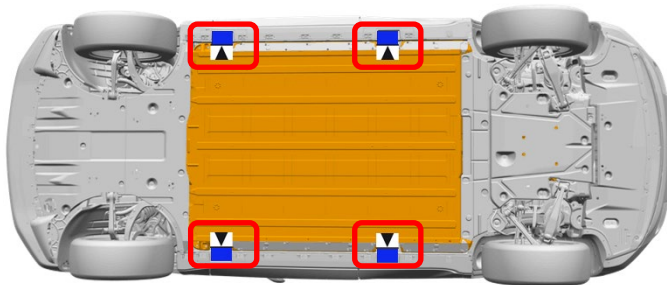

The vehicle lift points are shown in blue.

**DO NOT** lift the vehicle from any locations on the high-voltage battery (orange).





### Thermal Runaway Mitigation

The ZDX is equipped with a battery management system with internal fault detection, including thermal runaway mitigation. In the event of a **Battery Danger Detected** notification, **DO NOT** cut or disable the 12-volt system unless you need to disable the airbags for occupant extrication.

Automatic safety systems are enabled when 12-volt power is available, including a battery thermal runaway mitigation system that internally cools the high-voltage battery when a thermal event is detected. This feature is available in a non-crashed, static situations.

When these safeguards are activated, AcuraLink Connected by OnStar Advisors will contact First Responders. Information about this feature will be displayed on the driver instrument panel including a **Battery Danger Detected** message. The vehicle will also activate the horn and the hazard lights.



Connected by



### High-Voltage Shutdown Procedure

Before attempting to rescue occupants or move a damaged ZDX, you should reduce the potential for current to flow from the electric motor or the high-voltage battery through the high-voltage cables. There are **two recommended methods** for preventing current flow.

#### Power Button

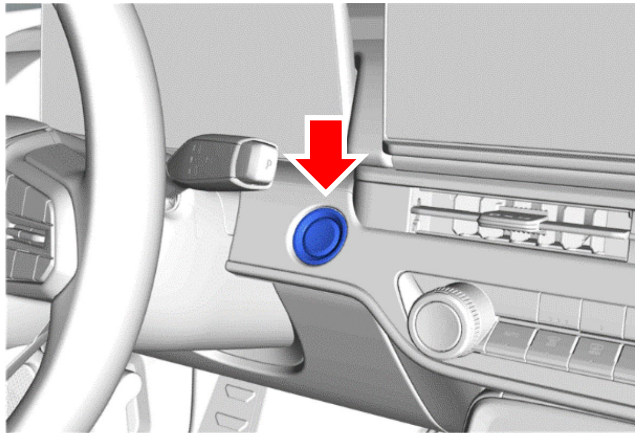

If the vehicle is already in **PARK**, press the **POWER** button to disable vehicle propulsion.

Alternatively, press and hold the **POWER** button. The electric drive unit will shift to P (Park) then shut off automatically.

The high-voltage system can remain energized even when the vehicle is in the **OFF** state.

#### Isolate Keyless Remote



To prevent accidental restarting, you must remove the keyless remote from the vehicle and move it at least **6m** away.

If you cannot locate the keyless remote, disconnect the negative terminal from the 12-volt battery to prevent electrical fires and accidental restarting of the vehicle.



### High-Voltage Shutdown Procedure

#### Hood Release

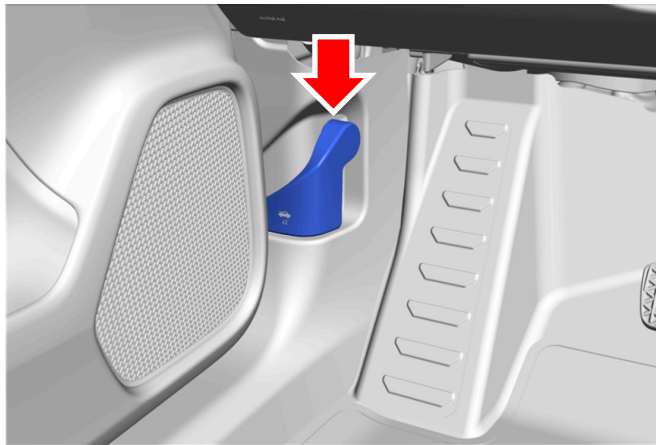

1. Pull the hood release handle on the lower-left side of the instrument panel.
2. Release the handle, then pull the handle again to fully open the hood.
3. Go to the front of the vehicle and lift the hood open.

#### Hood Release

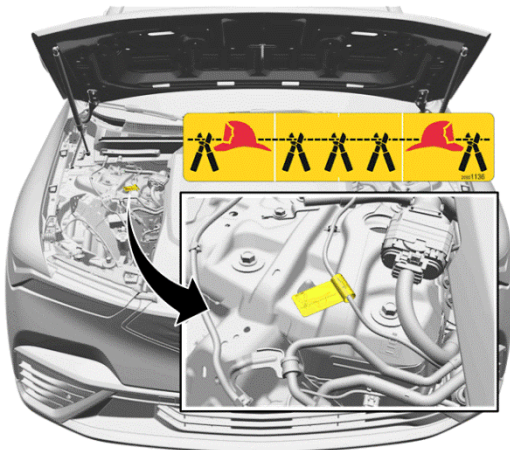

Double cut the 12-volt cables on both sides of the cut point label and remove the cut section of the cable from the vehicle. Ensure that the cuts are clean and that there is no risk of loose wires touching.

This cut will disable the airbags and high-voltage.

**DO NOT CUT ANY ORANGE COLOURED HIGH VOLTAGE CABLES.**

After disabling the 12-volt power, wait at least 10 seconds to allow any un-deployed airbag reserve energy to dissipate. Wait at least 1 minute to allow the high-voltage energy to discharge.



## High-Voltage Shutdown Procedure

### Vehicle at Charging Station

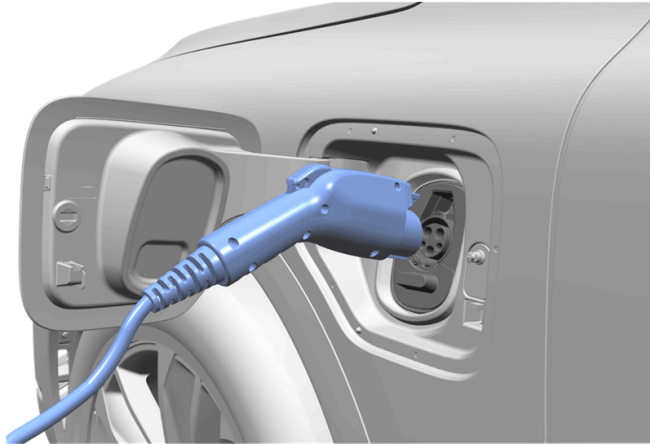

If you are able, stop vehicle charging by removing the charge handle from the vehicle by pressing the release button on top of the handle and pulling the handle out. If enabled, the vehicle's anti-theft alarm may activate.

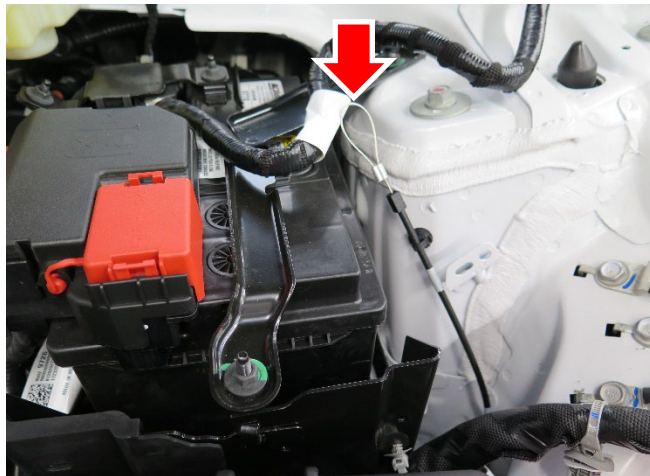

A common charge handle is shown. The DC-Fast Charge handle is moderately larger and may require additional effort to disconnect.

If the handle cannot be removed, open the hood and pull on the release cord located next to the 12-volt battery.



### Access to Occupants

#### Vehicle Glass



The windshield is made of Laminated Glass



The sunroof, door windows, rear quarter and rear window are made of Tempered Glass

#### Opening a Locked Door

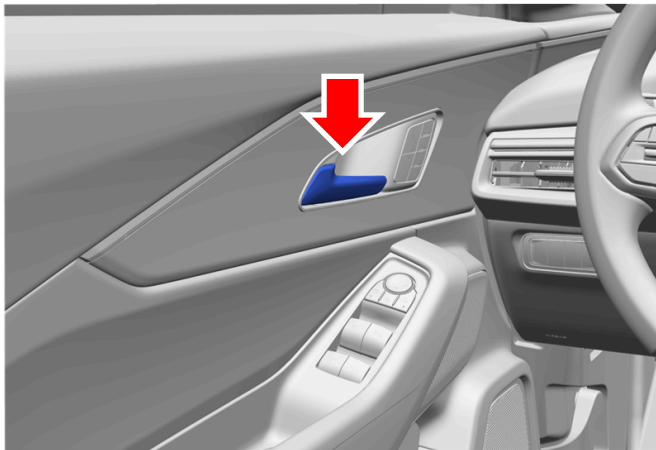

If the doors remain locked, pull twice on the inside door handle to gain access to the occupant at each seating location.

**NOTE:** An alternative method for rear passenger access may be necessary if the rear door child safety locks are engaged.

## Access to Occupants

### Steering Column Tilt and Telescoping Control

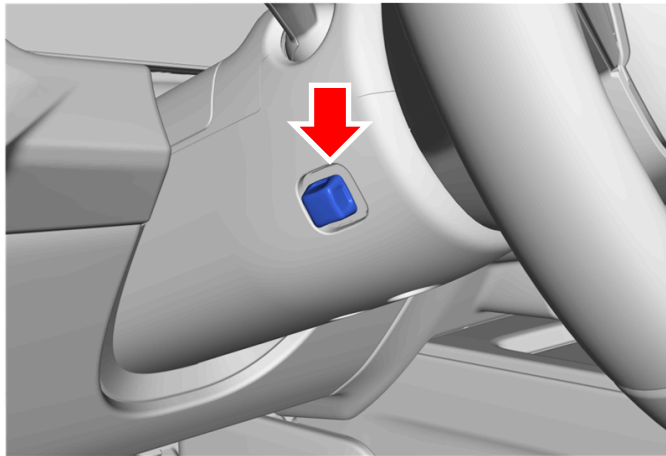

Press the switch up or down to tilt the steering wheel up or down.  
Press the switch rearward or forward to move the steering wheel closer or away from you.

### Seat Control Switches

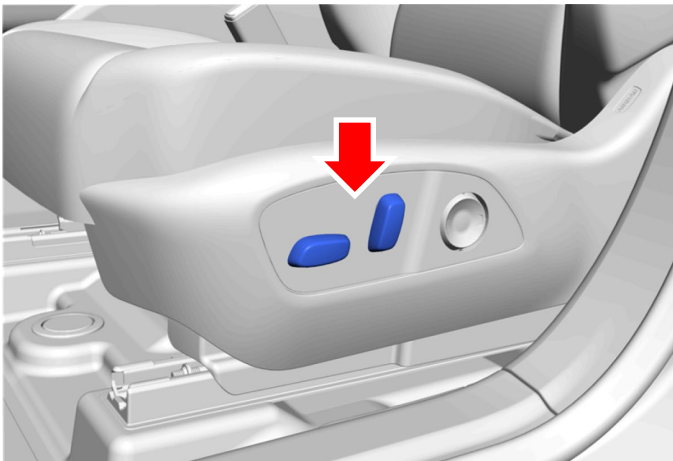

#### Front Switch

- Move the seat forward or rearward by sliding the control forward or rearward.
- Raise or lower the seat by moving the control up or down.

#### Rear Switch

Rotate the switch forward to raise the seatback and rearward to recline the seatback.







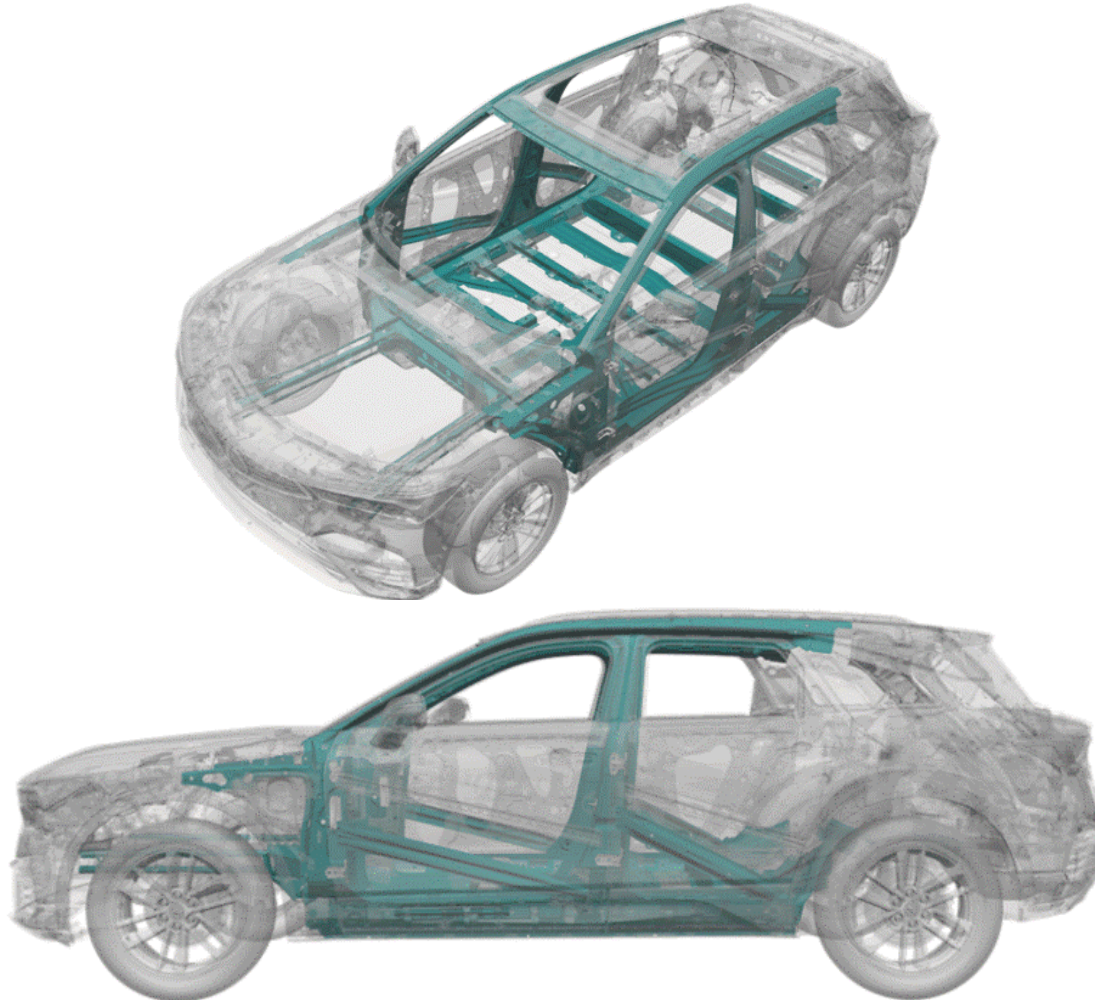

### High-Strength and Ultra-High-Strength Steel

The body of the ZDX is made of high-strength steel and ultra-high-strength steel indicated in the coloured areas. The passenger compartment is protected using high-strength steel in the pillars, rocker panels, door reinforcement beams, and floor structure.

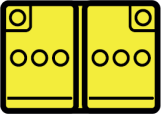

**As with any occupant extrication, exercise caution. The vehicle's high-voltage cables and components may be energized with high voltage. Avoid touching or cutting high-voltage cables or components during any rescue operation.**









Type	Dangers
	<p><b>12-Volt Lead Acid Battery</b> Low-voltage, lead acid chemistry battery</p>
	<p><b>400-Volt Lithium-Ion, High-Voltage Battery</b> High-voltage lithium-ion chemistry battery</p>
	<p>High-voltage warning, potential for electric shock</p>
	<p>Gases emitted from the battery pack are flammable</p>
	<p>Gases emitted from the battery pack are toxic</p>
	<ul style="list-style-type: none"> <li>- Skin contact may cause irritation. Prolonged contact with electrolyte mixture may result in more severe irritation.</li> <li>- Flush contaminated skin with plenty of water.</li> </ul>



**Coolant leaking inside the high-voltage battery can become unstable and possibly a risk for a fire. Check the battery temperature using a thermal imaging camera.**



Type	Dangers
	<p>High-voltage warning, potential for electric shock</p>
	<p>A battery on fire will not explode</p>
	<p>A battery on fire will not explode. If battery cells reach high enough temperatures, they vent and release electrolyte. Battery electrolyte is flammable.</p>
	<p>Gases emitted from the battery are toxic</p>
	<p>Skin contact may cause irritation. Prolonged contact with electrolyte mixture may result in more severe irritation. Flush contaminated skin with plenty of water.</p>
	<p>Potential for eye, nose, and throat irritation with prolonged exposure.</p>
	<ul style="list-style-type: none"> <li>– Always wear Self-Contained Breathing Apparatus (SCBA).</li> <li>– Use generous amounts of water to cool the battery and to extinguish a fire.</li> <li>– Do <b><u>NOT</u></b> use an ABC dry chemical extinguisher because it will not extinguish a battery fire.</li> </ul>



**Potential for Battery Re-Ignition.**

### In Case of Submersion

The high-voltage battery is isolated from the vehicle chassis. If the vehicle is immersed in water, there is no risk of electrocution by touching the vehicle.

After a vehicle is removed from the water, do the following:

1. Allow the vehicle to dry out
2. Perform the high-voltage shutdown procedure as describe in Section 3



### Tow Hook

Carefully open the cover on the bumper fascia by using the small notch that conceals the tow eye socket.

Install the tow eye into the socket and turn it until it is fully tightened. When the tow eye is removed, reinstall the cover with the notch in the original position.

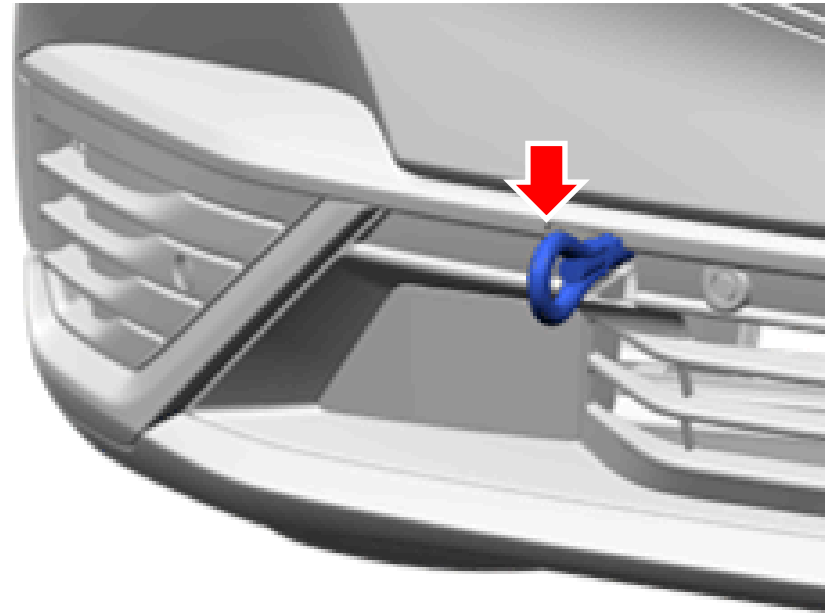
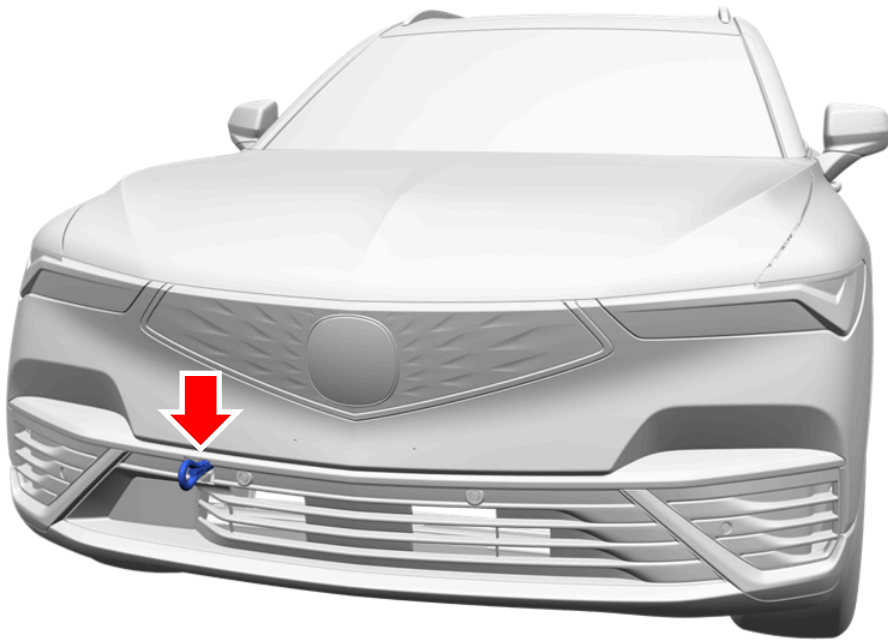





### Vehicle Towing and Transportation

The preferred method for emergency towing is to use a flat-bed tow truck or tow dollies to transport a disabled vehicle. If tow dollies must be used, be sure to suspend the rear wheels or both front and rear wheels. **DO NOT** use cable-type lift equipment.

**NOTE:** If there is a 12-volt power failure, the vehicle cannot be shifted into neutral. Use available tow dollies.

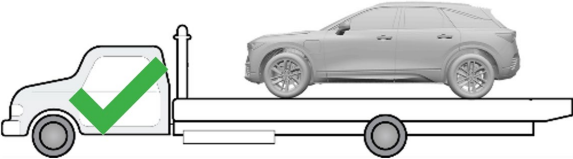
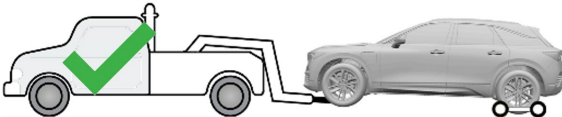
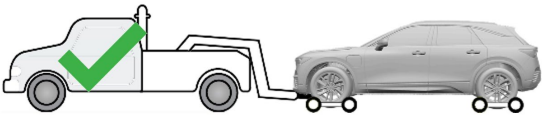
Moving the vehicle with the drive wheels on the ground will generate unwanted energy. Limit the movement of the vehicle to the distance required to prepare the vehicle for towing.

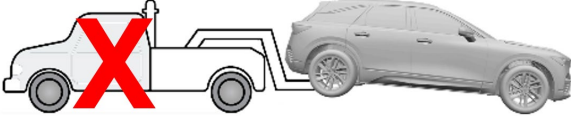
Carry a fire extinguisher during transportation and, for enhanced safety, have the flat-bed tow truck with the damaged vehicle followed by another support vehicle for monitoring. After transportation, isolate the vehicle if necessary. Refer to the next page.

Towing Types		
		
		

### **⚠ WARNING**

If the orange high-voltage cables or high-voltage covers have been damaged, exposing wiring, terminals, or other components, the exposed parts never should be touched. Doing so could result in serious injury or death due to severe burns or electric shock.

If it is not clear whether the exposed wires and terminals are high-voltage components, do not touch them.

**If touching high-voltage cables and other high-voltage components is unavoidable, personal insulating protective equipment (insulating gloves, protective goggles, and insulating boots) always should be worn.**



### Post-Crash Vehicle Storage

The damaged vehicle can be stored in either Open Perimeter Isolation or Barrier Isolation.

#### Open Perimeter Isolation

Store the vehicle in an outdoor area separated from all combustibles and structures by a minimum distance of 15m (50ft.) from all sides.

#### Barrier Isolation

- Store the vehicle in an outdoor area separated from all combustibles and structures with a barrier constructed of earth, steel, concrete or solid masonry designed to contain a fire or prevent the fire from extending to adjacent vehicles.
- The barriers should be of sufficient height to direct any flame or heat away from adjacent vehicles.
- If the barrier is only on three of the four sides of the vehicle, the open side must maintain the separation distance referenced above.
- It is not recommended to fully enclose the vehicle in a structure due to the risk of post-incident fire extending to the structure and the possibility of trapped explosive or harmful gases. Therefore, a roof is not recommended for barrier isolation.



**Potential for continued hazards (rekindling/re-gassing/etc.) if a damaged vehicle battery is jostled during recovery, including the towing and storage process.**



**After a “Battery Danger Detected” notification, or thermal runaway mitigation cycle completes, it might be appropriate to wait up to an hour before towing to a certified dealer for vehicle inspection even though evidence of a thermal event such as smoke may not be visible, and unusual odors may not be detected from the vehicle.**

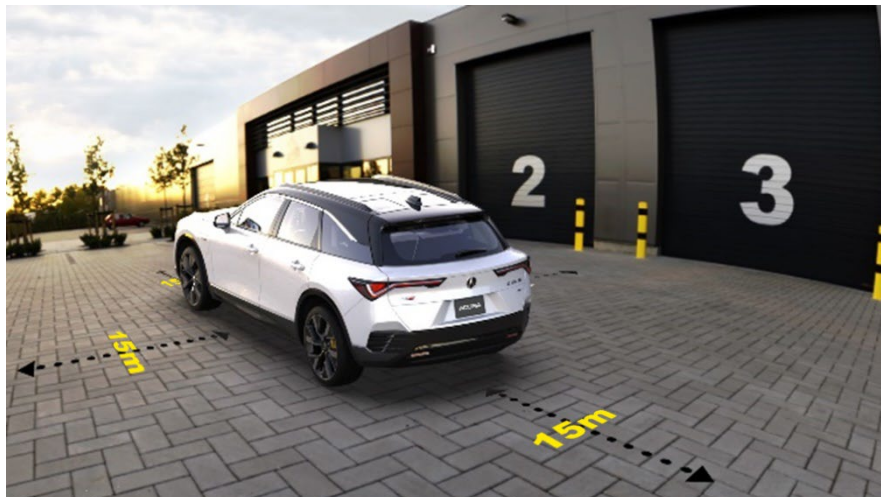

## Lithium-Ion Battery Fumes or Fire

A damaged high-voltage lithium-ion battery can emit toxic fumes, and the organic solvent used as electrolyte is flammable and corrosive. Responders should wear appropriate personal protective equipment. Even after a lithium-ion battery fire appears to have been extinguished, a renewed or delayed fire can occur. The battery manufacturer cautions responders that extinguishing a lithium-ion battery fire will take a large and sustained volume of water.

***In order to minimize the possibility of collateral fire damage, responders should always ensure that a ZDX with a damaged battery is kept outdoors and far away from other flammable objects.***



## Lithium-Ion Battery Fluid

Avoid contact with the high-voltage battery fluid. The high-voltage battery contains a flammable electrolyte that could leak as a result of a severe crash. Avoid any skin or eye contact with the electrolyte as it is corrosive. If you accidentally touch it, flush your eyes or skin with a large quantity of water for at least **5 minutes** and seek medical attention immediately.

## Electric Shock

Unprotected contact with any electrically charged high-voltage component can cause serious injury or death. Receiving an electric shock is highly unlikely because of the following:

- Contact with the battery module or other high-voltage components can only occur if they are damaged and the contents are exposed, or if they are accessed without following proper precautions.
- Contact with the electric motor can only occur after one or more components are removed.
- The high-voltage cables can be easily identified by their distinctive orange colour and contact with them can be avoided.

***If severe damage causes high-voltage components to become exposed, responders should take appropriate precautions and wear appropriate insulated personal protective equipment.***



## Disposal

The lithium-ion battery, the high-voltage battery coolant, and the water used to extinguish a battery must be properly disposed of as industrial waste according to local regulations.

### Vehicle Collision

In the event of a crash, the supplemental restraint system (SRS) unit makes a judgment based on input from the impact sensors. If the input values meet various threshold requirements, the SRS unit sends a signal to the high-voltage battery electronic control unit (ECU). The high-voltage battery ECU then turns off the high-voltage battery contactors, stopping the flow of electrical current from the high-voltage battery.

When responding to an incident involving a ZDX, we recommend that emergency personnel follow their organization's standard operating procedures for assessing and dealing with vehicle emergencies.

Acura recommends that responders follow the procedures in this guide to avoid potentially lethal shock from high voltage.



### Seat Belts and Airbags

The ZDX is equipped with eight airbags:





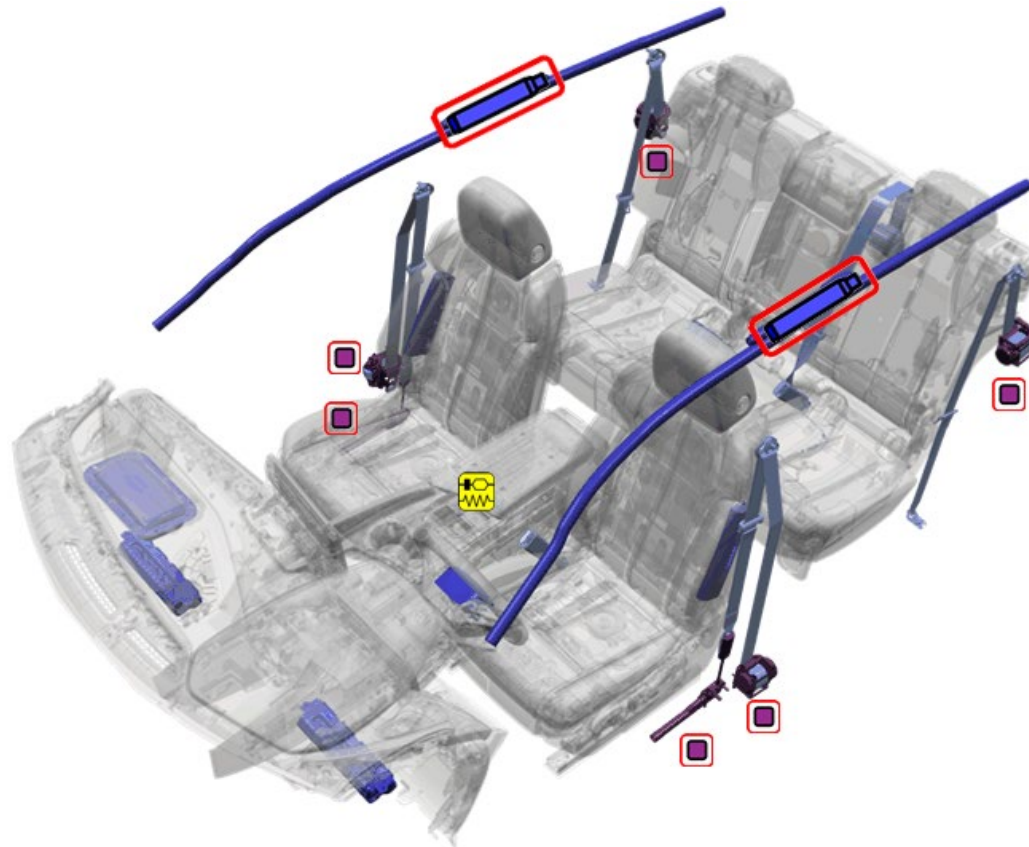





- Driver (Steering Wheel)
- Front Seat Passenger (Instrument Panel)
- (2) Front Knee Bolster Airbags
- (2) Front Seat Outboard Airbags
- (2) Roof Rail Airbags

There are seat belt restraints for five occupants. The front seat belt system includes two pre-tensioners on each side. One is seat belt retractor mounted and the other is mounted to the seat belt anchor at the base of the seat. The outboard rear seat belt retractors also have pre-tensioners.





### Components

	<b>SRS Components</b>
	<b>Stored Gas Inflator</b>
	<b>Seat Belt Pretensioner</b>
	<b>SRS Control Unit</b>
	<b>Gas Strut / Preloaded Spring</b>
	<b>High-Strength Zone</b>
	<b>12-Volt Battery</b>
	<b>High-Voltage Battery</b>
	<b>High-Voltage Cable</b>
	<b>Cable Cut Location</b>
	<b>High-Voltage Components</b>

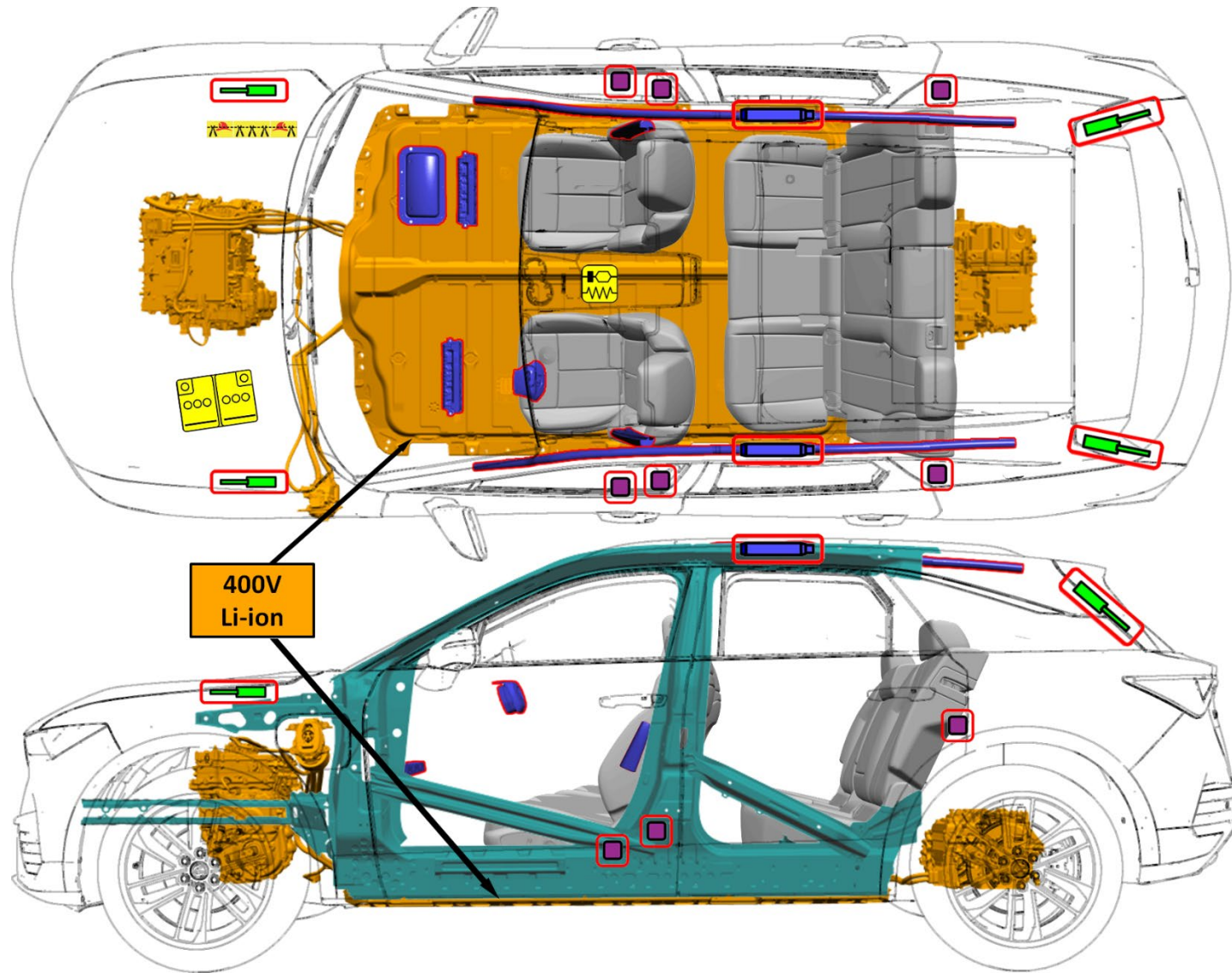

### Dealer Inspection and Repair

A damaged ZDX should be taken to an authorized Acura dealer for a thorough inspection and repairs. For questions or to locate an authorized Acura dealer, please contact your local Acura dealer or Acura Client Service at **1-888-922-8729**.



### High-Voltage Battery Recycling

The high-voltage lithium-ion battery requires special handling and disposal. If disposal is necessary, please contact your local Acura dealer or Acura Client Service at **1-888-922-8729**.



This guide has been prepared to assist emergency response professionals in identifying a 2024 Acura ZDX vehicle and safely respond to incidents involving this vehicle.



















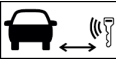

Copies of this guide and other emergency response guides are available for reference or downloading at:

<https://techinfo.honda.com>.

For questions, please contact your local Acura dealer Acura Client Service at **1-888-922-8729**.

Acura wishes to thank emergency response professionals for their concern and efforts in protecting Acura clients and the general public.



Pictogram	Name	Pictogram	Name
	Hood release/opener control		High-voltage component
	Steering wheel height adjustment control		High-voltage power cable
	Seat height adjustment control		General warning
	Forward or backward seat adjustment control		Electricity or dangerous voltage
	Power switch		Use water to extinguish the fire
	Lifting point		Toxic
	Keyless operation key distance		Flammable
	Cable to cut to disconnect high-voltage		Corrosive
	12-volt battery		Hazardous to human health
	Lithium-Ion, High-Voltage Battery		Use a thermal infrared camera

**ACURA**